

# FMT

Medical Sensors, Cables and Accessories



# DIAGNOSTIC EKG CABLES & ACCESSORIES

REV.41 0702.2023





Yoke Type	Compatible Model	Patient End	Color Code
00 FMT E100 Monolithic (non detachable leads)		B 4.0 mm isolated banana	I IEC
01 FMT E101 All detachable leads		P 3.2 mm straight pin	A AHA
03 FMT E103 5+5 detachable leads (GE Multi Link)		S Snap	
04 FMT E104 5+5 detachable leads (GE Multi Link 12SL)		G Grabber	
05 FMT E105 5+5 detachable leads (Philips)		O Trunk cable without leadwire	
06 FMT E106 4+6 detachable leads (Medtronic Physio Control)			
07 FMT E107 4 Fixed 6 Replaceable Leads (Schiller)			

To determine the part code enter specified parameter values instead of X.

**1** FMT Diagnostic EKG cables are monolithic or with replaceable leads compatible with various trunk cable types for different EKG devices. Available options may be determined from "Yoke Types" section.

Full part number is valid for trunk cable and grouped leads. If you would like to buy the trunk cable without leads, just write "0" value for patient end -field 4-, after filling other sections.

**2** You can find cables for various brands and models, resistor values in "Compatible Models" section.

**3 4** Patient end connections can be selected from banana, straight pin, grabber or snap options. You can choose Patient End code and IEC or AHA color code from "Leadwires Patient Ends" section.

EKG Cables have 1.80 m trunk cable length (Ø6.0 mm), 80 cm chest and 100 cm extremity lead lengths (Ø3.0 mm). Other lengths are available upon request.

## Yoke Types

• E100 type yoke



One piece 10 lead (non detachable leads).

• E101 type yoke



10 lead (all detachable leads)

• E103 type yoke



10 lead (5+5 detachable leads), GE MULTI-LINK type yoke.

• E104 type yoke



10 lead (5+5 detachable leads), GE MULTI-LINK 12SL type yoke.

• E105 type yoke



10 lead (5+5 detachable leads), PHILIPS type yoke.

• E106 type yoke



10 lead (4+6 detachable leads), Medtronic/Physio Control type yoke.

• E107 type yoke



10 lead (4+6 detachable leads), Schiller type yoke.

# Diagnostic EKG Cables & Accessories

Compatible Brands & Models

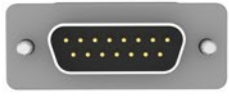

15 pin D-sub connector with screws



E100/DNY/Z  
E101/DNY/Z

E100/DRY/Z  
E101/DRY/Z

10 kΩ

**Philips/HP** M1770A(Pagewriter 200i-300i), M1771A (Pagewriter 200), M1772A (Pagewriter 100), Cable OEM M3703C. **Bionet** All Models. **BTL** All Models. **Aspel** All Models. **Innomed** All Models. **Mortara** ELI150, ELI210, ELI250, ELI350.

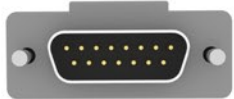

15 pin D-sub connector with screws



E100/SRY/Z  
E101/SRY/Z

10 kΩ

**Schiller** AT, AT1, AT2, AT3, AT5, AT6, AT10, AT60, A104 PC, CS100, CS6, CS6/12, AT101, AT102, AT104. **Esaote** P80, P120. **Kontron** P80.

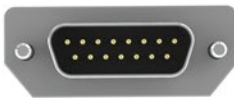

15 pin D-sub connector with screws



E100/NNY/Z  
E101/NNY/Z

E100/NRY/Z  
E101/NRY/Z

10 kΩ

**Nihon Kohden Cardiofax** C6151, 6353, 8270, 8350, 8370, 8420, 8423, 8450, 8453, 8820, 8823, 8830, 9620, 9010, 9020, 9022, 9110, 9130, 9132. **Dong Jiang** All Models. **Biocare** All Models. **Cardioline** AR600, AR1200, ELAN, ELAN1100, Cardiette Excel 103, 106, 112, 212, Deadalus Models, Microruler & Autoruler Models.



15 pin D-sub connector



E100/GRY/Z  
E101/GRY/Z  
E103/GRY/Z

10 kΩ

**GE** Microsmart, MAC500 MAC1000, MAC1100, MAC1200ST, MAC400, MAC600, MAC800, MAC1600.



15 pin D-sub connector with screws



E100/ERY/Z  
E101/ERY/Z

10 kΩ

**Edan** SE-1200 Express, SE-12, SE-12 Express, SE-601, SE-3, SE-1. **Mindray** DECG-03A.



16 pin circular connector



E100/CRY/Z  
E101/CRY/Z

4.7 kΩ

**Cardioline** Delta 1, 3, 30, 60, Delta 1 plus, Delta 3 plus, Delta 60 plus. **Suzuken Kenz** 103, 106.



15 pin D-sub connector with latch on the top



E100/KRY/Z  
E101/KRY/Z

10 kΩ

**Fukuda** ME KP-5000.



15 pin D-sub connector with 45 degree angle and locking plastic latches



E100/HRY/Z  
E101/HRY/Z

10 kΩ

**Bosch** 603D, 603ER, 603S, 606. **Customed**, **Hellige** EK36, EK41, EK43, EK53, EK56, EK403, 413, 512, E512P, Cardiosmart, Cardiosys. **Siemens** Sicard 440/440S, 460/460S, 740, Sicard 803, Sirecust 701, Cathcor, Cardiostat 1,3T, 703, 710, Cardinex 3T, 4, 6T, 703, 710, Megacard Elema A13, R, R/E, Miracard1. **Hörmann** Bioset9000.



15 pin D-sub connector with locking metal latches



E100/FNY/Z  
E101/FNY/Z

-

E100/FRY/Z  
E101/FRY/Z

10 kΩ

**Fukuda Denshi** Autocardiner, Cardiomax, FX2111, FX7411, FX7402, FX7202, FX2155, FX3010, FX7102.

# Diagnostic EKG Cables & Accessories

Compatible Brands & Models



E100/MRY/Z  
E101/MRY/Z

10 kΩ

Mortara ELI 50, ELI 100, ELI 200.

15 pin D-sub connector with locking plastic latches



E100/LNY/Z  
E101/LNY/Z

-

PETAŞ Kardiopet 300, 500.

12 pin circular connector

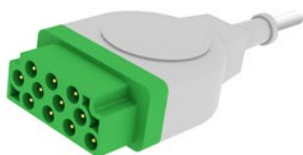

E100/BNY/Z  
E101/BNY/Z  
E104/BNY/Z

-

GE Solar 7000/8000/9500, DASH 2500, 3000, 4000, 5000, Eagle 500, 1000, 3000, 5000, BP30, Dinamap PRO 1000, MAC-Lab, Tram Modules.

11 pin rectangular connector

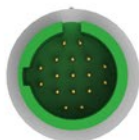

E100/TRY/Z  
E101/TRY/Z

1 kΩ

Spacelabs Ultraview 90496.

17 pin circular connector

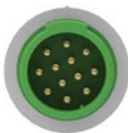

E100/YRY/Z  
E101/YRY/Z

10 kΩ

Fukuda Denshi DS7300.

12 pin circular connector



E100/ZRY/Z

10 kΩ

TEPA All Stress Modules.  
*Only Grabber and Snap options are available.*

15 pin DB15 female connector with screws



E100/JRY/Z  
E101/JRY/Z

10 kΩ

Burdick Eclipse, 4, 8, 400, 800, LE11, 850, 8501, Eclipse Plus, ATRIA, ATRIA PLUS, ATRIA 3000.

15 pin D-sub connector



E100/ARY/Z  
E101/ARY/Z

4.7 kΩ

Trismed All Models.

15 pin D-sub connector with screws



E100/ONY/Z  
E101/ONY/Z

-

Carewell ECG1101, 1103, 1106, 1112, T10, T12.

15 pin D-sub connector with screws

# Diagnostic EKG Cables & Accessories

Compatible Brands & Models



12 pin circular connector



E100/RRY/Z 10 kΩ  
E106/RRY/Z

Medtronic Physio Control Lifepak 12/20.  
*Only Grabber and Snap options are available.*



12 pin circular connector



E100/PRY/Z 1-3.2 kΩ  
E105/PRY/Z

Philips / HP M1949A.  
*Only Grabber and Snap options are available.*

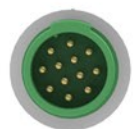

12 pin circular connector



E100/IRY/Z 10 kΩ

Progetti Rescue Life Defibrillator.  
*Only Grabber and Snap options are available.*



15 pin connector



E100/WRY/Z 10 kΩ  
E107/WRY/Z

Zoll M Series.  
*Only Grabber and Snap options are available.*

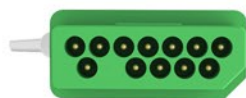

12 pin rectangular connector



E100/QNY/Z -

Nihon Kohden TEC-8300K Series Defibrillator.  
*Only Grabber and Snap options are available.*



13 pin circular connector



E100/VRY/Z 1 kΩ

Metrax Primedic Defimonitor EVO, Mediana D500.  
*Only Grabber and Snap options are available.*



13 pin circular connector



E107/URG/Z 1 kΩ

Schiller Argus Pro Lifecare 2, Defigard Touch 7,  
Physiogard Touch 7  
*Only Grabber option is available.*

# Diagnostic EKG Cables & Accessories

Leadwires

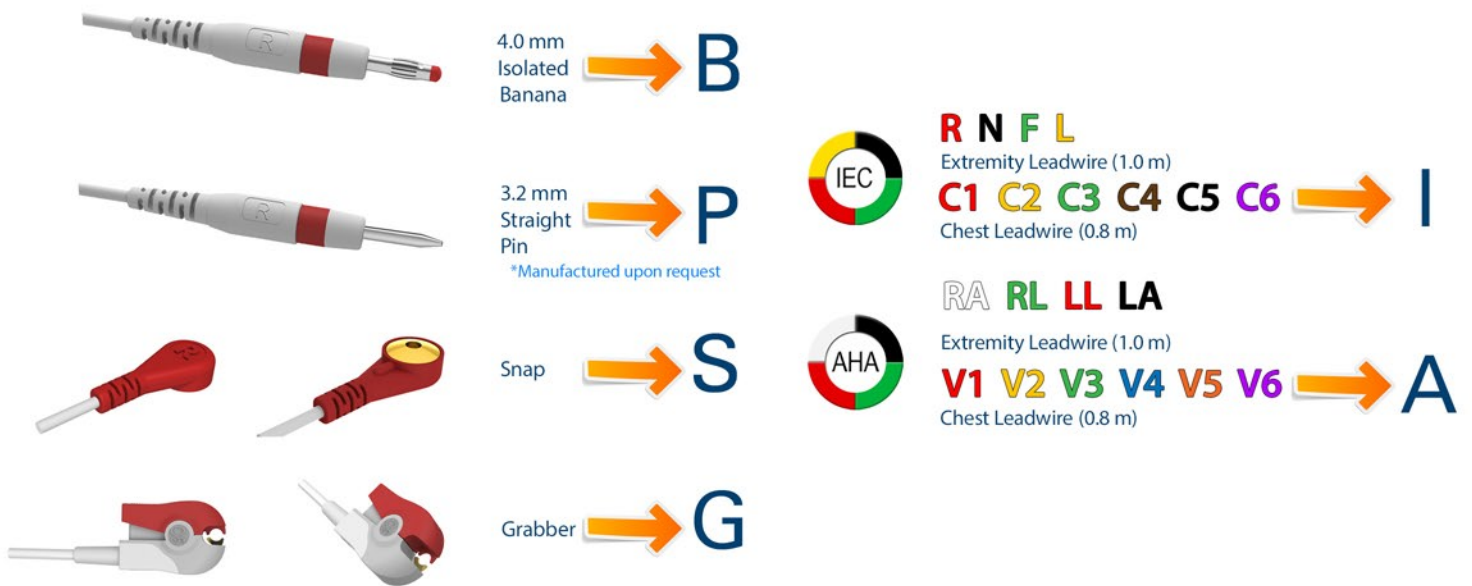

• "B" for 4.0 mm isolated banana, "P" for 3.2 mm straight pin, "S" for snap, "G" for grabber, "I" for IEC color coding, "A" for AHA color coding.

## Replacement Leadwires

You can determine the part number using the below table to order as a set. A Special Indicator is used to distinguish some grouped leadwire sets consisting of different leadwire combinations. Please see the relevant pictures.

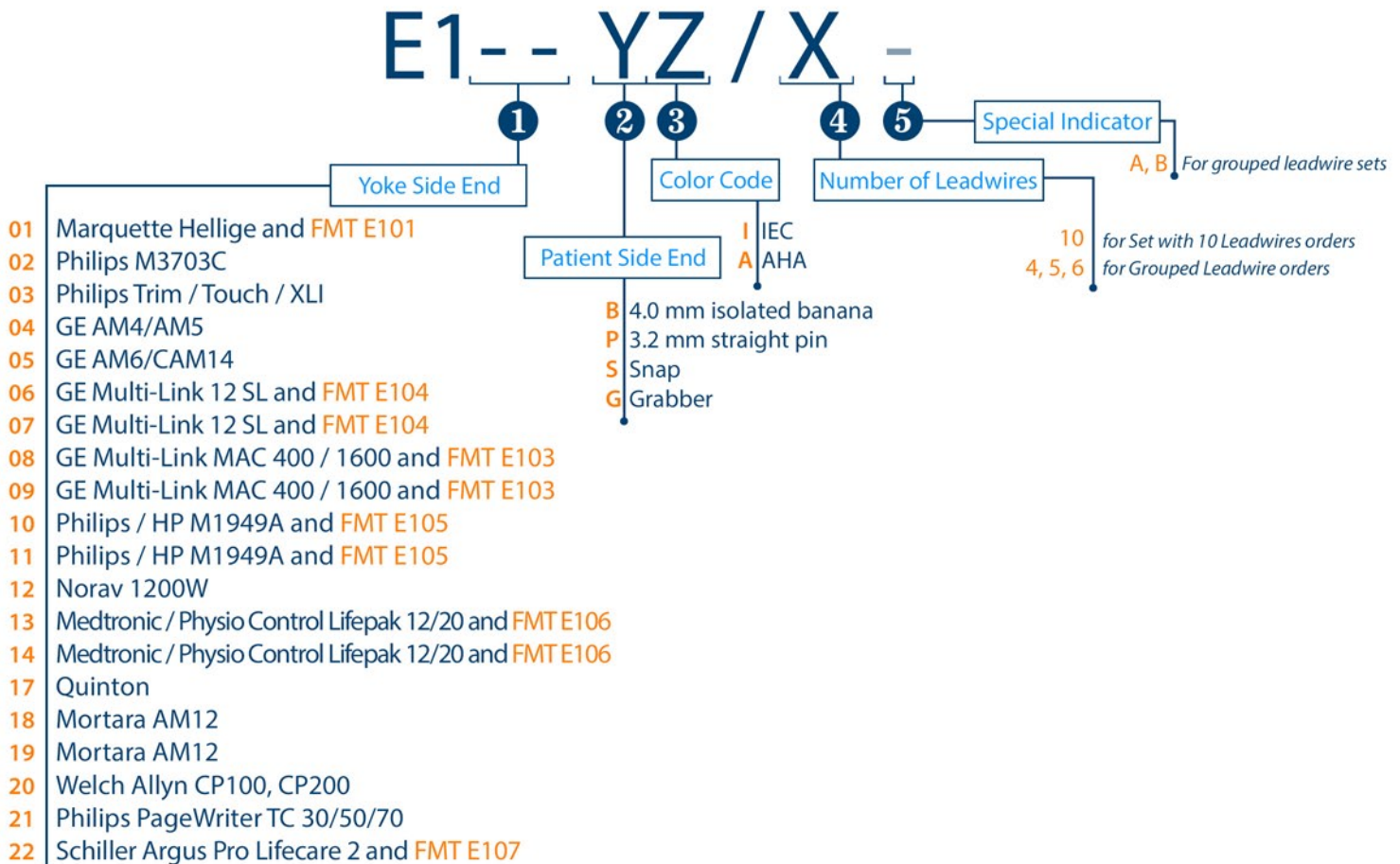

# Diagnostic EKG Cables & Accessories

Leadwires

- **E101YZ/10** Leadwire for Marquette Hellige and FMT E101 cable yokes. (R/N/F/L 110 cm, C1/C2/C3/C4/C5/C6 80 cm)



Example:  
E101BI/R leadwire  
with banana end,  
IEC color code, R

- **E102YZ/10** Leadwire for Philips M3703C EKG Module. (R/N/F/L 110 cm, C1/C2/C3/C4/C5/C6 80 cm)



Example:  
E102BI/R leadwire  
with banana end,  
IEC color code, R

- **E103YZ/10** Leadwire for Philips PageWriter Trim/Touch/XLI EKG Module. (R/N/F/L 110 cm, C1/C2/C3/C4/C5/C6 80 cm)



Example:  
E103BI/R leadwire  
with banana end,  
IEC color code, R

- **E104YZ/10** Leadwire for GE AM4/AM5 EKG Module. (R/N/F/L 110 cm, C1/C2/C3/C4/C5/C6 80 cm)



Example:  
E104BI/R leadwire  
with banana end,  
IEC color code, R

- **E105YZ/10** Leadwire for GE AM6/CAM14 Module and FMT E103 cable yoke. (R/N/F/L 110 cm, C1/C2/C3/C4/C5/C6 80 cm)



Example:  
E105BI/R leadwire  
with banana end,  
IEC color code, R

- **E106YZ/5** Grouped Leadwire for GE Multi-Link 12 SL and FMT E104 cable yokes. (R/N/F/L/C 100 cm)



Example:  
E106SI/5 Leadwire  
set with 5 snap end,  
IEC color code, (N,R,L,F,C)

- **E107YZ/5** Grouped Leadwire for GE Multi-Link 12 SL and FMT E104 cable yokes. (C2/C3/C4/C5/C6 100 cm)



Example:  
E107SI/5 Leadwire  
set with 5 snap end,  
IEC color code, (C2,C3,C4,C5,C6)

- **E108YZ/5** Grouped Leadwire for GE Multi-Link MAC 400 / 1600 and FMT E103 cable yokes. (N/R 110cm, C1/C2/C3 80cm)



Example:  
E108SI/5 leadwire set  
with 5 snap end,  
IEC color code, (N,R,C1,C2,C3)

- **E109YZ/5** Grouped Leadwire for GE Multi-Link MAC 400 / 1600 and FMT E103 cable yokes. (L/F 110cm, C4/C5/C6 80cm)



Example:  
E109SI/5 leadwire set  
with 5 snap end,  
IEC color code, (C4, C5, C6, L, F)

# Diagnostic EKG Cables & Accessories

## Leadwires

- **E110GZ/5-OR** Grouped Leadwire with ESU protection for **Philips/HP M1668A, M1663A, M1949A** and **FMT E105** cable yokes. (C/R/L/ 100cm, F/N 160cm) *Only Grabber option is available.*



Example:  
E110GI/5-OR leadwire with  
5 grabber end, IEC Color Code  
(N, L, F, R, C/C1)

- **E111GZ/5-OR** Grouped Leadwire with ESU protection for **Philips/HP M1663A, M1949A** and **FMT E105** cable yokes. (C6/C5/C4/C3/C2 100cm)  
*Only Grabber option is available.*



Example:  
E111GI/5-OR leadwire with ,  
5 grabber end, IEC Color Code,  
(C6, C5, C4, C3, C2)

- **E110YZ/5** Grouped Leadwire for **Philips/HP M1663A, M1949A** and **FMT E105** cable yokes. (C1/R/F/L/N 100cm)



Example:  
E110SI/5 leadwire with  
5 snap end, IEC color code,  
(C1, R, F, L, N)

- **E111YZ/5** Grouped Leadwire for **Philips/HP M1663A, M1949A** and **FMT E105** cable yokes. (C6/C5/C4/C3/C2 100cm)



Example:  
E111SI/5 leadwire with  
5 snap end, IEC color code,  
(C6, C5, C4, C3, C2)

- **E112YZ/10** Leadwire for **Norav 1200W Module**. (R/L/N/F 110cm, C1/C2/C3/C4/C5/C6 80cm)  
*Only Grabber and Snap options are available.*



Example:  
E112GI/R leadwire with  
grabber end, IEC color code, R

- **E113YZ/4** Grouped Leadwire for **Medtronic / Physio Control Lifepak 12/20** and **FMT E106** cable yokes. (F/L/R/N 100cm)



Example:  
E113GI/4 leadwire with  
4 grabber end, IEC color code,  
(F, L, R, N)

- **E114YZ/6** Grouped Leadwire for **Medtronic / Physio Control Lifepak 12/20** and **FMT E106** cable yokes. (C1/C2/C3/C4/C5/C6 100cm)



Example:  
E114GI/6 leadwire with  
6 grabber end, IEC color code,  
(C1, C2, C3, C4, C5, C6)

- **E117YZ/10** Leadwire for **Quinton stress test module**. (R/L/N/F 110cm, C1/C2/C3/C4/C5/C6 80cm)  
*Only Grabber and Snap options are available.*



Example:  
E117GI/R leadwire with  
grabber end, IEC color code, R



# Diagnostic EKG Cables & Accessories

Leadwires

- **E118YZ/10** Leadwire for **Mortara** AM12 and WAM EKG module. (N/R/L/F 120cm, C1/C2/C3/C4/C5/C6 90cm)

Only Banana and Grabber options are available.



- E118BI/5A(N, R, C1, C2, C3)
- E118BA/5A(RL, RA, V1, V2, V3)



- E118BI/5B (C4, C5, C6, L, F)
- E118BA/5B (V4, V5, V6, LA, LL)

Example:  
E118BI/10 leadwire with banana end, IEC color code, (N, R, C1, C2, C3, C4, C5, C6, L, F)

- **E119GZ/10** Leadwire for **Mortara** AM12 and WAM Stress EKG module. (N/R/L 75cm, C1/C2 70cm, C3/C4/C5/C6 60cm, F 43cm)

Only Grabber option is available.



- E119GI/5A(N, R, C1, C2, C3)
- E119GA/5A(RL, RA, V1, V2, V3)

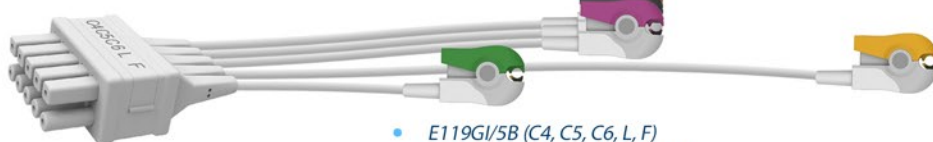

- E119GI/5B (C4, C5, C6, L, F)
- E119GA/5B (V4, V5, V6, LA, LL)

Example:  
E119GI/10 leadwire with grabber end, IEC color code, (N, R, C1, C2, C3, C4, C5, C6, L, F)

- **E120YZ/10** Leadwire for **Welch Allyn** CP100, CP200 patient cable. (R/L/N/F 110cm, C1/C2/C3/C4/C5/C6 80cm)



Example:  
E120BI/R leadwire with banana end, IEC color code, R

- **E121BZ/10** Leadwire for **Philips** PageWriter, TC 30/50/70. (N/R/L/F 100 cm, C1/C2/C3/C4/C5/C6 70cm)

Only Banana option is available.



- E121BI/3A(C1, C2, C3)
- E121BA/3A(V1, V2, V3)



- E121BI/3B (C4, C5, C6)
- E121BA/3B(V4, V5, V6)

Example:  
E121BI/10 leadwire with banana end, IEC color code



- E120BI/R, E120BI/F, E120BI/L, E120BI/N
- E120BA/RA, E120BA/LL, E120BA/LA, E120BA/RL

- **E122GZ/6** Leadwire for **Schiller** Argus Pro Lifecare 2 and **FMT E107** (C1/C2/C3/C4/C5/C6 40cm)

Only Grabber option is available.



Example:  
E122GI/6 leadwire with grabber end, IEC color code

## Clamp Electrodes

- Universal connection is suitable for use with 3.2 mm straight pin, 4.0 mm banana or snap lead termination leadwires.
- All of the metallic surfaces are Silver–Silver Chloride (Ag/AgCl) plated to provide maximum signal quality.
- Color coded IEC or AHA protocols.
- The lengths of clamp electrodes are 140 mm for adult size, 89 mm for pediatric size.
- Supplied in package of 4 pieces set.

Adult	IEC	CEA11	Package 4 pcs./set, Red, Green, Yellow, Black
Adult	AHA	CEAA1	Package 4 pcs./set, Red, Green, White, Black
Pediatric	IEC	CEA12	Package 4 pcs./set, Red, Green, Yellow, Black
Pediatric	AHA	CEAA2	Package 4 pcs./set, Red, Green, White, Black



## Suction Chest Electrode

- Suction chest electrodes with universal connection, are suitable for use with 3.2 mm straight pin, 4.0 mm banana or snap lead termination leadwires.
- All of the metallic surfaces are Silver–Silver Chloride (Ag/AgCl) plated to provide maximum signal quality.
- The outer diameter of adult suction bowl is 24.0 mm. The diameter of the silicone bulb is 30.0 mm. The diameter of pediatric suction bowl is 17.0 mm. The diameter of the silicone bulb is 21.4 mm.
- Supplied in package of 6 pieces set.

Adult	SE1	Package 6 pcs./set
Pediatric	SE2	Package 6 pcs./set

## Banana to Snap Adaptor

- Banana to Snap Adaptors allows you to easily connect 3.2 mm straight pin and 4.0 mm banana plug leadwires to disposable ECG electrodes with 4.0 mm snap studs.
- Banana to Snap Adaptors supplied in package of 10 pieces set.



- **BS3** 3.2 mm straight pin to snap adaptor, Grey, Package 10 pcs./set
- **BS4** 4.0 mm banana to snap adaptor, White, Package 10 pcs./set

## Banana to Alligator Clip Adaptor

- Allows you to easily connect 4.0 mm banana plug leadwires to disposable ECG electrodes with tab connectors.
- Supplied in package of 10 pieces set.

**BA4** 4.0 mm banana to alligator adaptor, 10 pcs./set



## Banana to Grabber Adaptor

- Converts 3.2 mm straight pin and 4.0 mm banana plug leadwires to disposable ECG electrodes with 4.0 mm snap studs.
- Supplied in package of 10 pieces set.

<b>BG3I/10</b>	3.2 mm straight pin to grabber adaptor, Grey, IEC color code, Package	10 pcs./set
<b>BG3A/10</b>	3.2 mm straight pin to grabber adaptor, Grey, AHA color code, Package	10 pcs./set
<b>BG4/10</b>	4.0 mm banana to grabber adaptor, White, Package	10 pcs./set



FMT is registered trademark of **Metko Ltd.**



### **Headquarter & Factory**

İvedik O.S.B. Ağaç İşleri Sanayi Sit.  
1354. Cad. 1358.Sok. No:9  
06378 Yenimahalle

**ANKARA / TÜRKİYE**

Tel (pbx) : +90 312 387 12 46  
Fax : +90 312 387 12 51

### **Branch**

Atatürk Mah. Sedef Cad. 38.Ada  
Ata Plaza 3-5 Blokları Kat:2 No:57  
34758 Ataşehir

**İSTANBUL / TÜRKİYE**

Tel (pbx) : +90 216 455 91 21  
Fax : +90 216 455 48 24

[www.metkold.com](http://www.metkold.com)

Other products, logos and company names mentioned herein may be trademarks of their respective owners and are not to be taken as an endorsement of affiliation with FMT®. The information in this catalogue has been carefully checked and it is believed to be accurate. Images in this catalogue are representative of items offered. Actual product may have slight visual differences. In the interest of continued product development, Metko reserves the right to make changes and improvements to this catalogue and the product it described any time, without notice or obligation.